

# AT 系列气动执行器

AT SERIES PNEUMATIC ACTUATORS

可视指示器  
Versa View  
Continuous  
Indicator

NAMUR标准安装孔  
NAMUR  
Mounting

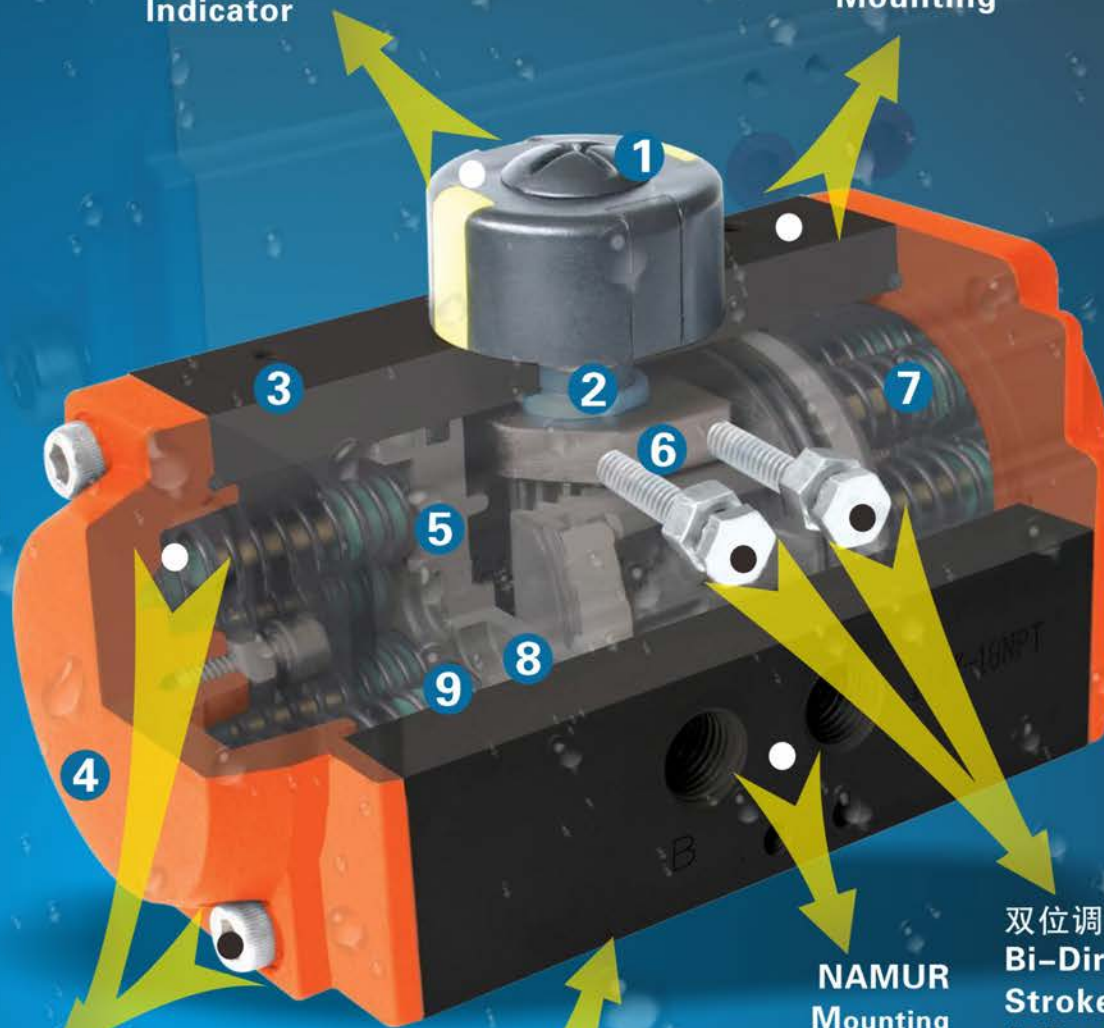

Stainless  
Steel  
Fasteners  
不锈钢紧固件

ISO  
Mounting  
ISO标准安装孔

NAMUR  
Mounting  
NAMUR标准安装孔

双位调节  
Bi-Directional  
Stroke  
Adjustment

## ■ Construction 结构

### 1、Indicator 指示器

Position indicator with NAMUR is convenient for mounting accessories such as Limit Switch box, Positioner and so on. NAMUR 标准指示器便于安装位置开关、定位器等附件。

### 2、Pinion 输出轴

The pinion is high-precision and integrative, made from nickelled-alloy steel, full conform to the latest standards of ISO5211, DIN3337, NAMUR. The dimensions can be customized and the stainless steel is available.

镀镍合金钢、高精度一体式输出轴同时符合NAMUR、ISO5211、DIN3337标准。可根据客户要求定制尺寸和不锈钢材料。

### 3、Actuator Body 缸体

According to the different requirements, the extruded aluminum alloy ASTM6005 Body can be treated with hard anodized, powder polyester painted (different colours is available such as blue, orange, yellow etc.), PTFE or Nickel plated.

ASTM6005压铸铝合金缸体可以采用硬质氧化、环氧树脂喷涂(根据要求喷涂蓝色、橙色、黄色等)、PTFE涂层或镀镍满足不同要求。

### 4、End caps 端盖

Die-casting aluminum powder polyester painted in different colours, PTFE or Nickel plated.

压铸铝合金表面金属粉末喷涂各种颜色、PTFE涂层或镀镍处理。

### 5、Pistons 活塞

The twin rack pistons are made from Die-casting aluminum treated with Hard anodized or made from Cast steel with galvanization. Symmetric mounting position, long cycle life and fast operation, reversing rotation by simply inverting the pistons.

双活塞齿条、采用铸铝硬质氧化或者铸钢镀锌处理, 安装位置对称、运作迅速、使用寿命长, 简单的颠倒活塞可以改变旋转方向。

### 6、Travel adjustment 行程调节

The two independent external travel stop adjustment bolts can adjust  $\pm 5^\circ$  at both open and close directions easily and precisely.

两个独立的行程调节螺钉可以进行方便、精确 $\pm 5^\circ$ 的调节开关位置。

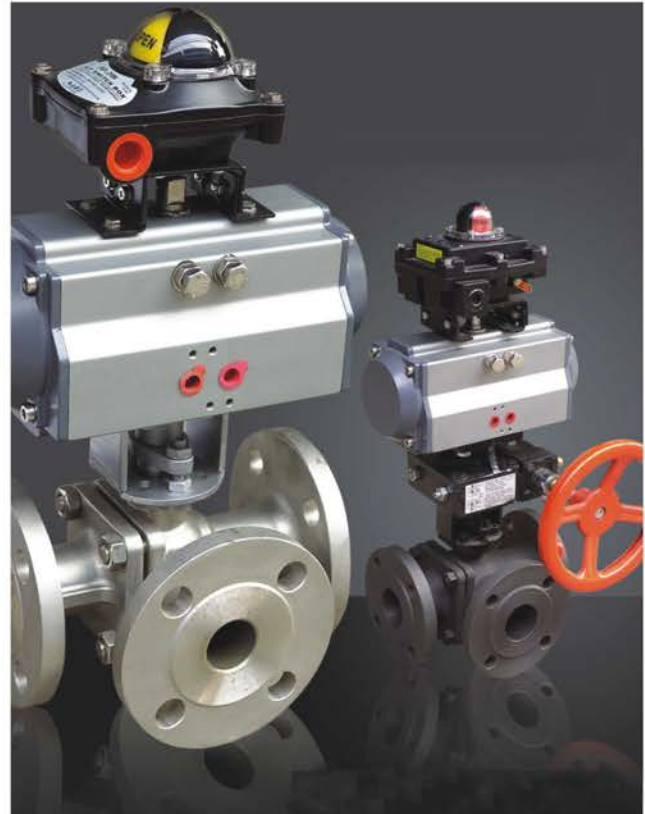

### 7、High performance springs 高性能弹簧

Preloaded coating springs are made from the high quality material for resistant to corrosion and longer service life, which can be demounted safely and conveniently to satisfy different requirements of torque by changing quantity of springs.

采用优质材料、涂层处理, 预压装配。具有较强的抗腐蚀性和使用寿命。能够安全、简单的拆卸单作用执行器, 通过改变弹簧数量满足不同的力矩输出范围。

### 8、Bearings & Guides 轴承、导板

Made from low friction, long-life compound material, to avoid the direct contact between metals. The maintenance and replacement are easy and convenient.

采用低摩擦、长寿命复合材料, 避免了金属与金属的直接接触, 维修更换简单方便。

### 9、O-rings 密封

NBR rubber O-rings provide trouble-free operation at standard temperature ranges. For high and low temperature applications Viton or Silicone.

在常温工作条件下使用丁腈橡胶, 在高温或低温时采用氟橡胶或硅橡胶。

■ Parts and Material 零件和材料

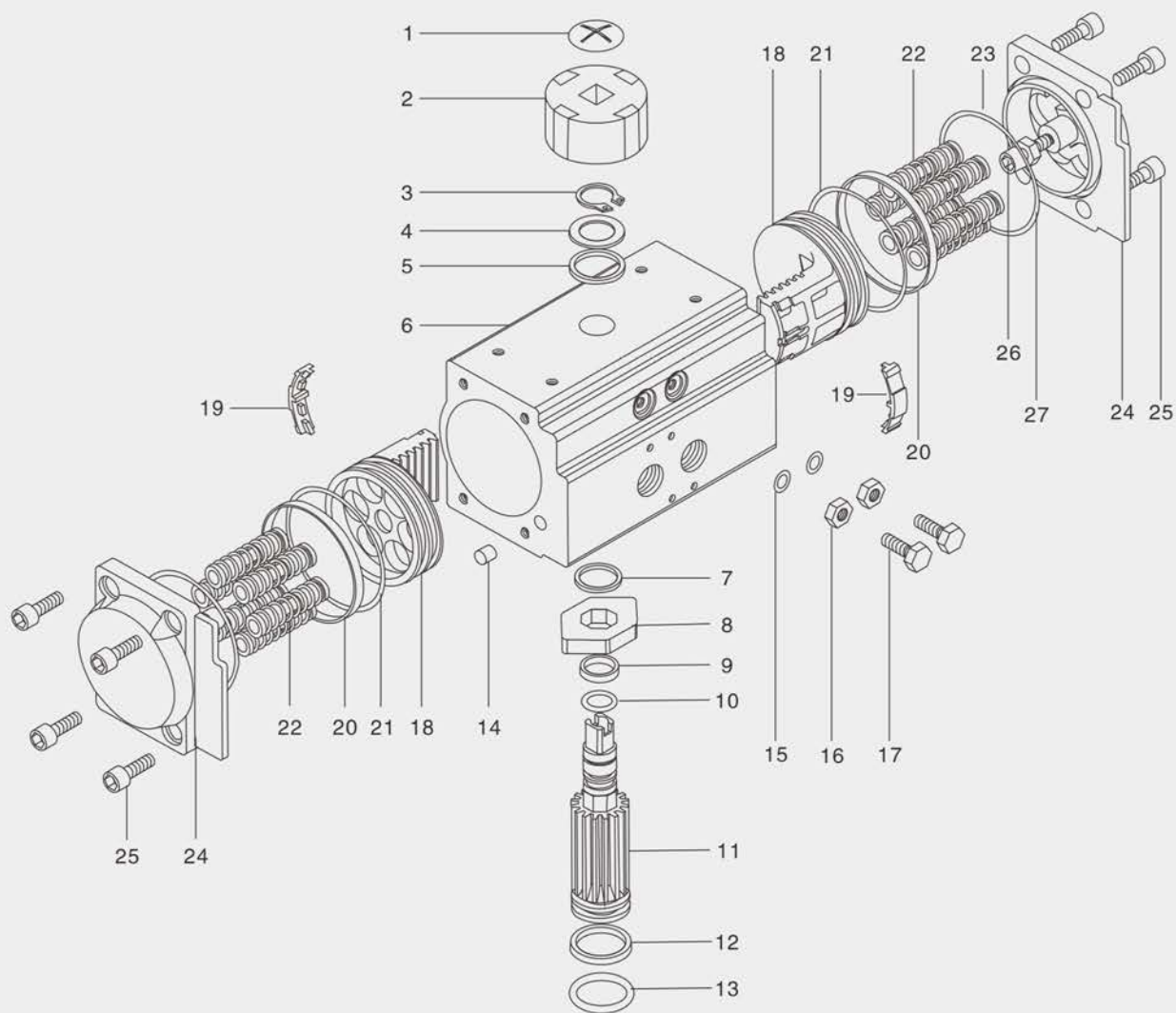

序号	名称	数量	材料	防腐处理	可选材料
1	指示器螺钉	1	塑料		
2	指示器	1	塑料		
3	卡簧	1	不锈钢		
4	垫圈	1	不锈钢		
5	外垫片	1	工程塑料		
6	缸体	1	铸铝	硬质氧化等	
7	内垫片	1	工程塑料		
8	凸轮	1	合金钢		
9	上轴O圈	1	丁腈橡胶		氟橡胶/硅橡胶
10	上轴轴承	1	工程塑料		不锈钢
11	齿轴	1	合金钢	镀镍	
12	下轴轴承	1	工程塑料		
13	下轴O圈	1	丁腈橡胶		氟橡胶/硅橡胶
14	堵头	2	丁腈橡胶		氟橡胶/硅橡胶
15	调节螺钉O圈	2	丁腈橡胶		氟橡胶/硅橡胶
16	调节螺钉螺母	2	不锈钢		
17	调节螺栓	2	不锈钢		
18	活塞	2	铸铝/铸钢	氧化/镀锌	不锈钢
19	活塞导板	2	工程塑料		
20	活塞轴承	2	工程塑料		
21	活塞O圈	2	丁腈橡胶		氟橡胶/硅橡胶
22	弹簧	0~12	弹簧钢	浸漆	
23	端盖O圈	2	丁腈橡胶		氟橡胶/硅橡胶
24	端盖	2	铸铝	粉末喷涂等	
25	端盖螺栓	8	不锈钢		
26	限位螺栓	2	不锈钢		
27	限位螺母	2	不锈钢		

No.	Description	Qty	STANDARD MATERIAL	PROTECTION	OPTIONAL MATERIAL
1	Indicator screw	1	Plastic		
2	Indicator	1	Plastic		
3	Spring clip	1	Stainless Steel		
4	Thrust washer	1	Stainless Steel		
5	Outside washer	1	Engineering plastics		
6	Body	1	Extruded aluminum alloy	Hard anodized etc	
7	Inside washer	1	Engineering plastics		
8	Cam	1	Alloy steel		
9	O-ring (pinion top)	1	NBR		Viton/Silicone
10	Bearing (pinion top)	1	Engineering plastics		Stainless Steel
11	Pinion	1	Alloy steel	Nickel plated	
12	O-ring (pinion bottom)	1	Engineering plastics		
13	Bearing (pinion bottom)	1	NBR		Viton/Silicone
14	Plug	2	NBR		Viton/Silicone
15	O-ring (Adjust screw)	2	NBR		Viton/Silicone
16	Nut (Adjust screw)	2	Stainless Steel		
17	Adjust screw	2	Stainless Steel		
18	Piston	2	Cast aluminum/casting	Anodized/Zinc galvanized	Stainless Steel
19	Guide (Piston)	2	Engineering plastics		
20	Bearing (Piston)	2	Engineering plastics		
21	O-ring (Piston)	2	NBR		Viton/Silicone
22	Spring	0~12	Spring steel	Dip coating	
23	O-ring (End cap)	2	NBR		Viton/Silicone
24	End cap	2	Cast aluminum	Powder polyster painted etc	
25	Cap screw	8	Stainless Steel		
26	Stop screw	2	Stainless Steel		
27	Nut (stop screw)	2	Stainless Steel		

■ Double Acting Actuators 双作用执行器

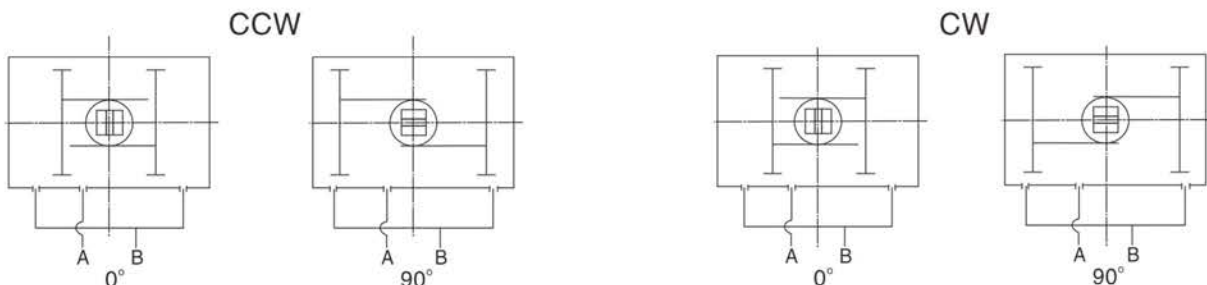

Air to Port A forces the pistons outwards, causing the pinion to turn counterclockwise while the air is being exhausted from Port B.

Air to Port B forces the pistons inwards, causing the pinion to turn clockwise while the air is being exhausted from Port A.

A口进气，压缩空气推动活塞向外运动，使执行器输出轴逆时针旋转(0°-90°)，B口排气。

B口进气，压缩空气推动活塞向内运动，使执行器输出轴顺时针旋转(90°-0°)，A口排气。

Air to Port A forces the pistons outwards, causing the pinion to turn clockwise while the air is being exhausted from Port B. Air to Port B forces the pistons inwards, causing the pinion to turn counterclockwise while the air is being exhausted from Port A.

A口进气，压缩空气推动活塞向外运动，使执行器输出轴顺时针旋转(0°-90°)，B口排气。

B口进气，压缩空气推动活塞向内运动，使执行器输出轴逆时针旋转(90°-0°)，A口排气。

■ Output Torque Of Double Acting Actuators 双作用执行器输出力矩(Unit:N.m)

Model 型号	Air supply pressure (Unit: Bar) 输入气源压力(单位: 巴)									
	2	2.5	3	4	4.5	5	5.5	6	7	8
AT52DA	8.0	10.0	12.0	16.0	18.0	20.0	21.9	23.9	27.9	31.9
AT65DA	14.6	18.2	21.9	29.2	32.8	36.5	40.1	43.8	51.1	58.4
AT75DA	20.1	25.1	30.1	40.1	45.1	50.2	55.2	60.2	70.2	80.3
AT85DA	31.4	39.2	47.0	62.7	70.5	78.4	86.2	94.1	109.7	125.4
AT92DA	45.1	56.4	67.7	90.3	101.6	112.9	124.1	135.4	158.0	180.6
AT105DA	66.1	82.7	99.2	132.2	148.8	165.3	181.8	198.4	231.4	264.5
AT125DA	100.3	125.4	150.5	200.6	225.7	250.8	275.9	301.0	351.1	401.3
AT140DA	171.0	213.8	256.5	342.0	384.8	427.5	470.3	513.0	598.5	684.0
AT160DA	266.0	332.5	399.0	532.0	598.5	665.0	731.5	798.0	931.0	1064.0
AT190DA	425.6	532.0	638.4	851.2	957.6	1064.0	1170.4	1276.8	1489.6	1702.4
AT210DA	532.0	665.0	798.0	1064.0	1197.0	1330.0	1463.0	1596.0	1862.0	2128.0
AT240DA	769.5	961.9	1154.3	1539.0	1731.4	1923.8	2116.1	2308.5	2693.3	3078.0
AT270DA	1169.6	1462.1	1754.5	2339.3	2631.7	2924.1	3216.5	3508.9	4093.7	4678.6

Selection of Double Acting Actuator:

The suggested safety factor for double acting actuators under normal working conditions is 20%-30%.

Example:

- The torque needed by valve=100N.m
- The torque considered safety factor (1+30%)=130N.m
- Air Supply=5Bar

According to the above table, we can choose the minimum model is AT160DA.

双作用执行器的选型:

在正常操作条件下，双作用执行器考虑的安全系数为20%-30%。

示例:

- 阀门力矩=100N.m
- 安全力矩=100×(1+30%)=130N.m
- 气源压力=5Bar

对照双作用力矩表，选配双作用执行器最小规格为AT160DA。

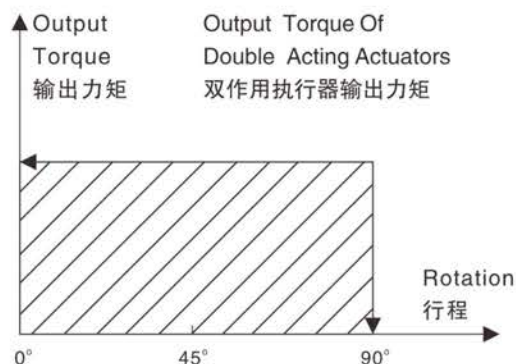

■ Spring Acting Actuators 单作用执行器

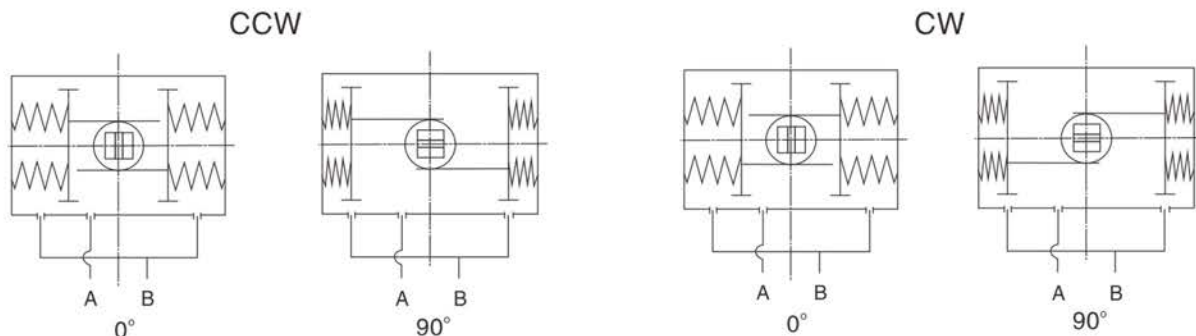

Air to port A forces the pistons outwards, causing the springs to compress. The pinion turns counter clockwise while air is being exhausted from port B.

Loss of air pressure on port A, the stored energy in the springs forces the pistons inwards. The pinion turns clockwise while air is being exhausted from port A.

A口进气,压缩空气克服弹簧力,推动活塞向外运动,执行器输出轴逆时针转动(0°→90°),B口排气;  
执行器失气,活塞在弹簧力的作用下向内运动,执行器输出轴顺时针转动(90°→0°),A口排气。

Air to port B forces the pistons outwards, causing the springs to compress. The pinion turns counterclockwise while air is being exhausted from port B.

Loss of air pressure on port A, the stored energy in the springs forces the pistons inwards. The pinion turns clockwise while air is being exhausted from port A.

A口进气,压缩空气克服弹簧力,推动活塞向外运动,执行器输出轴逆时针转动(0°→90°),B口排气;执行器失气,活塞在弹簧力的作用下向内运动,执行器输出轴逆时针转动(90°→0°),A口排气。

■ Output Torque Of Spring Return Actuators  
单作用执行器输出力矩

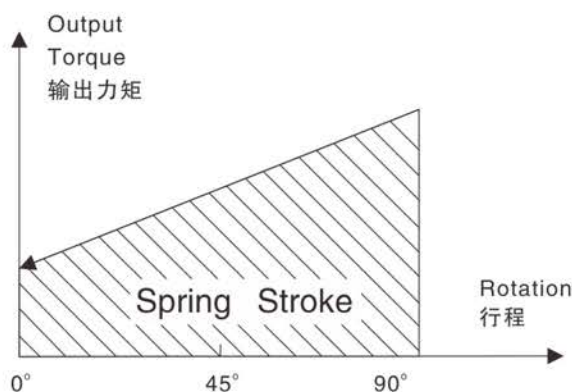
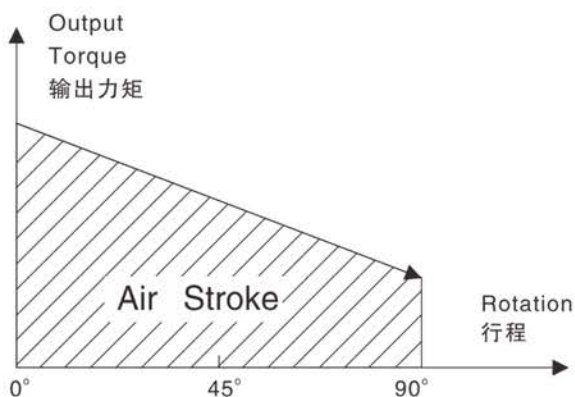

NOTE:

Make sure that the torque necessary to operate the valve is compatible with the actuator torque (It depends on both actuator type and air supply).

Please note that the requested torque depends not only on the valve, but on the working conditions and the safety margins of the plant in question, too.

注意:

确保执行器的输出扭矩和驱动阀门所需要的扭矩相符(执行器的型号和气源压力)。

请注意,选型扭矩不仅取决于阀门,还要考虑相关工况、安全系数等参数。

■ Output Torque of Spring Return Actuators 单作用执行器输出力矩(Unit: N.m)

		Output torque of air to springs 气源克服弹簧输出力矩																Springs' output 弹簧输出力矩			
Air pressure 气源压力		2.5Bar		3Bar		4Bar		5Bar		6Bar		7Bar		8Bar							
Model 型号	Spring Q.ty 弹簧数量	0°		90°		0°		90°		0°		90°		0°		90°		0°		90°	
		Start 开始	End 结束	Start 开始	End 结束	Start 开始	End 结束	Start 开始	End 结束	Start 开始	End 结束	Start 开始	End 结束	Start 开始	End 结束	Start 开始	End 结束	Start 开始	End 结束	Start 开始	End 结束
AT52SR	5	5.7	3.8	7.6	5.7													6.2	4.3		
	6	4.9	2.5	6.9	4.5	10.9	8.5											7.4	5.0		
	7	4.0	1.3	6.0	3.3	9.8	7.3	14.0	10.4									8.6	5.9		
	8			5.2	2.0	9.2	6.0	13.2	9.1	17.2	14.1							9.9	6.7		
	9			4.3	0.8	8.3	4.8	12.3	7.9	16.3	12.8	20.3	16.8					11.1	7.6		
	10					7.4	3.6	11.5	6.7	15.5	11.6	19.5	15.6					12.4	8.5		
	11					6.6	2.3	10.6	5.4	14.6	10.4	18.6	14.3	22.6	18.3			13.6	9.3		
	12							9.7	4.2	13.8	9.1	17.8	12.2	21.8	17.1	14.8	10.2				
	AT65SR	5	11.4	7.7	15.0	11.4	22.3	14.9											10.4	6.8	
		6	10.1	5.7	13.6	9.3	20.9	16.6	28.3	23.9									12.5	8.2	
		7	8.6	3.6	12.5	7.2	19.5	14.5	26.8	21.9									14.6	9.6	
		8			10.9	5.1	18.2	12.4	25.5	19.8	32.8	27.0	40.1	34.3					16.7	10.9	
9						16.8	10.4	24.1	17.7	31.4	24.9	38.7	32.2					18.8	12.3		
10						1.4	8.2	22.8	15.6	30.0	22.8	37.3	30.1	44.7	37.4	20.9	13.7				
11								21.5	13.5	28.7	20.7	36.0	28.0	43.3	35.3	22.9	15.0				
12								20.0	11.4	27.3	18.6	34.6	25.9	41.9	33.3	25.0	16.4				
AT75SR		5	14.5	10.6	19.4	15.5	29.5	25.7											14.5	10.5	
		6	12.4	7.6	17.3	12.6	27.4	22.7	37.5	32.8									17.4	12.7	
		7	10.4	4.8	15.2	9.7	25.3	19.9	35.4	29.9									20.3	14.8	
		8			13.1	6.8	23.1	16.9	33.3	27.0	43.2	37.0	53.3	47.0					23.2	16.9	
	9					21.0	14.1	31.2	24.1	41.1	34.1	51.2	44.2					26.1	19.0		
	10					19.0	11.1	28.8	21.2	39.0	31.2	49.1	41.2	59.1	51.2	29.0	21.1				
	11							27.0	18.3	37.0	28.3	47.0	38.4	57.0	48.4	31.9	23.2				
	12							24.9	15.4	34.9	25.4	44.9	35.4	54.9	45.4	34.7	25.3				
	AT85SR	5	23.3	16.1	31.1	24.0	46.8	39.7											23.0	15.8	
		6	20.1	11.5	28.0	19.3	43.7	35.1	59.4	50.7									27.6	19.0	
		7	17.0	6.9	24.8	14.8	40.5	30.5	56.2	46.2									32.2	22.1	
		8			21.7	10.1	37.4	25.8	53.1	41.5	68.8	57.2	84.5	72.9					36.8	25.3	
9						34.2	21.3	49.9	37.0	65.6	52.6	81.2	68.3					41.4	28.5		
10						31.0	16.6	46.7	32.3	62.4	48.0	78.1	63.7	93.8	79.3	46.0	31.6				
11								43.6	27.7	59.3	43.4	75.0	59.1	90.6	74.8	50.6	34.8				
12								40.4	23.2	56.1	38.9	71.7	54.5	87.4	70.2	55.2	38.0				
AT92SR		5	33.1	22.0	44.2	33.2	66.8	55.9											34.4	23.3	
		6	28.4	15.2	39.6	26.4	62.2	49.0	84.8	71.6									41.2	28.0	
		7	23.8	8.2	34.9	19.4	57.5	42.1	80.2	64.7									48.1	32.7	
		8			31.3	12.6	52.9	35.2	75.5	57.9	98.1	80.5	120.7	103.0					55.0	37.3	
	9					48.2	28.4	70.9	51.0	93.5	73.6	116.0	96.1					61.9	42.0		
	10					43.6	21.5	66.2	44.1	88.8	66.7	111.3	89.2	134.0	111.8	68.7	46.7				
	11							61.5	37.2	84.1	59.9	106.6	82.4	129.2	105.0	75.6	51.4				
	12							56.8	30.4	79.4	53.0	101.9	75.5	124.5	98.1	82.5	56.0				
	AT105SR	5	51.0	33.4	67.5	49.9	100.6	83.0											49.2	31.6	
		6	44.7	23.5	61.1	40.0	94.2	73.2	127.3	106.2									59.1	38.0	
		7	38.4	13.7	54.9	30.3	87.9	63.4	121.0	96.4									68.9	44.3	
		8			48.5	20.4	81.6	53.5	114.7	86.5	147.7	119.6	180.8	152.7					78.7	50.6	
9						75.3	43.7	108.4	76.8	141.5	109.8	174.5	142.9					88.6	56.9		
10						68.9	33.4	102.0	66.5	135.1	99.6	168.2	132.6	201.2	165.7	98.4	63.3				
11								95.7	57.0	128.7	90.1	161.8	123.1	194.8	156.2	108.3	69.6				
12								89.4	47.5	122.5	80.6	155.5	113.6	188.6	146.7	118.1	75.9				

■ Output Torque of Spring Return Actuators 单作用执行器输出力矩(Unit: N.m)

		Output torque of air to springs 气源克服弹簧输出力矩														Springs' output 弹簧输出力矩			
Air pressure 气源压力		2.5Bar		3Bar		4Bar		5Bar		6Bar		7Bar		8Bar					
Model 型号	Spring Qty 弹簧数量	0°		90°		0°		90°		0°		90°		0°		90°			
		Start 开始	End 结束	Start 开始	End 结束	Start 开始	End 结束	Start 开始	End 结束	Start 开始	End 结束	Start 开始	End 结束	Start 开始	End 结束	Start 开始	End 结束		
AT125SR	5	73	47	98	72	148	122										79	52	
	6	63	31	88	56	138	107	188	157								94	63	
	7	52	15	77	40	127	90	178	141								110	73	
	8			67	25	117	75	167	125	217	176	268	226				125	84	
	9					107	59	157	109	207	159	257	210				141	94	
	10					96	44	146	94	196	144	247	194	297	245		157	105	
	11							136	78	186	128	236	178	286	228		173	115	
	12							125	63	176	113	226	163	276	213		188	125	
	AT140SR	5	128	85	171	127	256	213										129	86
		6	111	59	154	102	239	187	325	273								155	103
		7	94	33	137	76	222	162	308	247								181	120
		8			120	50	205	136	291	221	376	307	462	392				206	137
9						187	110	273	196	358	281	444	367				232	155	
10						170	84	256	169	341	255	427	340	512	426		258	172	
11								238	143	324	229	409	314	495	400		284	189	
12								221	118	307	203	392	289	478	374		310	206	
AT160SR		5	193	124	259	191	392	324										208	140
		6	165	83	232	149	365	282	498	415								250	168
		7	137	41	203	107	336	240	469	373								292	196
		8			176	66	309	199	442	237	575	465	708	598				333	223
	9					280	157	413	290	546	423	679	556				375	251	
	10					253	115	386	248	519	381	652	514	785	647		417	279	
	11							358	207	491	340	624	473	757	606		458	307	
	12							330	165	463	298	596	431	729	564		500	335	
	AT190SR	5	332	222	438	329	651	542										309	200
		6	292	161	398	267	611	480	824	693								371	240
		7	252	99	358	205	571	418	784	631								433	280
		8			318	143	531	356	744	569	957	782	1169	995				495	320
9						491	295	704	507	917	720	1130	933				557	360	
10						451	233	664	446	877	658	1090	871	1302	1084		618	400	
11								624	384	837	597	1050	809	1263	1022		680	440	
12								584	322	797	535	1010	748	1223	960		742	480	
AT210SR		5	390	285	523	418	789	684										380	275
		6	335	209	468	342	734	608	1000	874								456	330
		7	280	133	413	266	679	532	945	798								532	385
		8			358	190	624	456	890	722	1156	988	1422	1254				608	440
	9					569	380	835	646	1101	912	1367	1178				684	495	
	10					514	304	780	570	1046	836	1312	1102	1578	1368		760	550	
	11							725	494	991	760	1257	1026	1523	1292		836	605	
	12							670	418	936	684	1202	950	1468	1216		912	660	
	AT240SR	5	552	409	744	600	1129	985										554	410
		6	470	297	662	489	1047	874	1432	1259								665	492
		7	388	187	580	379	964	764	1349	1149								775	575
		8			498	268	883	653	1267	1037	1652	1422	2037	1807				886	656
9						800	542	1185	926	1569	1311	1954	1696				998	739	
10						718	431	1103	816	1488	1201	1872	1586	2257	1970		1108	821	
11								1021	705	1406	1090	1791	1474	2176	1859		1219	903	
12								939	594	1323	979	1708	1363	2093	1748		1330	985	
AT270SR		5	903	675	1195	968	1779	1552										787	560
		6	790	519	1083	811	1667	1396	2252	1981								943	672
		7	679	361	972	654	1556	1238	2141	1823								1101	783
		8			860	497	1444	1081	2029	1666	2614	2252	3199	2836				1258	895
	9					1332	923	1917	1509	2502	2094	3087	2678				1416	1007	
	10					1220	767	1805	1352	2390	1937	2974	2521	3560	3107		1572	1119	
	11							1693	1194	2278	1779	2862	2364	3448	2949		1730	1231	
	12							1582	1037	2167	1623	2751	2207	3336	2792		1887	1342	



### ■ Selection of Single Acting Actuator

The suggested safety factor for spring return actuator under normal working conditions is 30%–50%.

#### Example:

The torque needed by valve=80N.m

The torque consider safety factor=80(1+30%)=104N.m

Air Supply=5Bar

According to the table of spring return actuators' output, we find output torque of AT140SR K7 is:

Air stroke 0° =308N.m

Air stroke 90° =247N.m

Spring stroke 90° =181N.m

Spring stroke 0° =120N.m

All the output torque is larger than we needed.

#### Attention:

During the spring reset of the single acting actuator, the actuator B port ventilation does not affect the actuator output torque, instead, it helps the spring reset.

### ■ 单作用执行器的选型

在正常工作条件下，单作用执行器考虑的安全系数为30%–50%。

#### 例如：

阀门需要力矩=80N.m

安全力矩=80(1+30%)=104N.m

气源压力=5Bar

对照单作用执行器输出力矩表，我们可以查到AT140SRK7输出力矩为：

空气行程0° =308N.m

空气行程90° =247N.m

弹簧行程90° =181N.m

弹簧行程0° =120N.m

所有输出力矩均大于我们需求。

#### 注意：

单作用执行器弹簧复位过程中，执行器B口通气不影响执行器输出力矩，相反帮助弹簧的复位。

### ■ Single Acting Actuator Spring Installation 单作用执行器弹簧安装形式



5 Springs

6 Springs

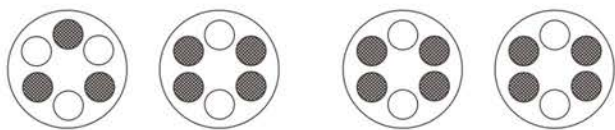

7 Springs

8 Springs

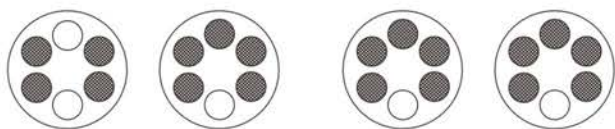

9 Springs

10 Springs

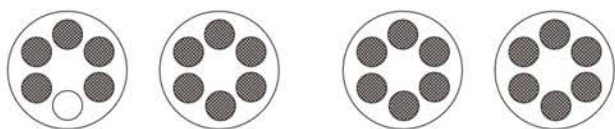

11 Springs

12 Springs

During selecting the spring return actuators, we can choose the more reasonable and more economical actuators, if we know the different torque needed by the valve working at opening, operating and closing.

在单作用执行器的选配过程中，如果能够了解阀门在开启、运行和关闭时的扭矩分配，我们就可以更加经济、更加合理地选配执行器。

#### Example:

The max torque needed by the butterfly valve=104N.m

The torque after opened (operating)104x30%=32N.m

Air Supply=5Bar

We can select the AT125SR K11 output torque is:

- Air stroke 0° =136N.m >104N.m
- Air stroke 90° =78N.m >32N.m
- Spring stroke 90° =173N.m >32N.m
- Spring stroke 0° =115N.m >104N.m

The above datas show the actuator's torque can satisfy the requirement of the butterfly valve.

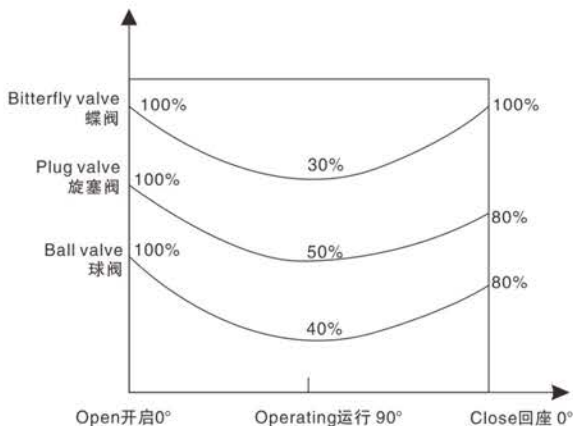

例如：

蝶阀原最大扭矩=104N.m

打开后扭矩 $104 \times 30\% = 32\text{N.m}$

气源压力=5Bar

我们可以选择AT125SR K11

● 空气行程0° =136N.m>104N.m

● 空气行程90° =78N.m>32N.m

● 弹簧行程90° =173N.m>32N.m

● 弹簧行程0° =115N.m>104N.m

以上数据显示可以满足该蝶阀的正常启闭。

## Operating Conditions

### 1. Operating media

Dry or lubricated air, or the non-corrosive gases the maximum particle diameter must less than 30 μm.

2. Air supply pressure the minimum supply pressure is 2.5 Bar, the maximum supply pressure is 8 Bar.

### 3. Operating temperature

Standard: -20°C~+80°C

Low temperature: -35°C~+80°C

High temperature: -15°C~+150°C

### 4. Travel adjustment

Have adjustment range of ±5° for the rotation at 0° and 90°.

### 5. Application

Either indoor or outdoor.

## 工作技术条件

### 1、工作介质

干燥或润滑的空气或无腐蚀性气体介质中杂质微粒小于30 μm。

### 2、气源压力

最小气源压力2.5巴，最大气源压力8巴。

### 3、介质环境温度

标准：-20°C~+80°C

低温：-35°C~+80°C

高温：-15°C~150°C

### 4、行程调节

0° 和90° 两个位置有 ±5° 的调节范围。

### 5、使用场合室内或室外安装。

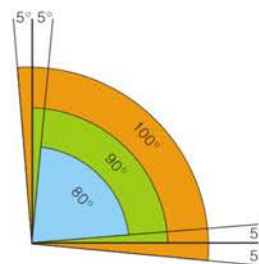

## Operating type(Single action and double action) 动作形式(单作用和双作用)



Air supply connection is designed in accordance with NAMUR Standard to install solenoid valves.

气源接口符合NAMUR标准，可简单方便地安装电磁阀。

The Namur drive pinion and the Namur top mounting connection permit direct installation of accessories such as limit switch box and positioner.

输出轴的NAMUR标准槽和缸体上部标准安装孔，可使限位开关、定位器直接啮合和安装。

Bottom mounting connection is designed in accordance with ISO5211 and DIN3337 standards for direct mounting with valve gear boxes or mounting brackets.

底部安装孔设计符合 ISO5211和 DIN3337标准，可以直接安装离合器(气动手轮机构)或安装支架。



Each actuator is marked with a serial number, air connection and bottom mounting holes are marked for easy track and distinction.

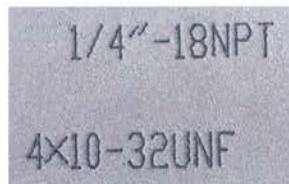

产品序列号、气源接口及底部安装孔全部电脑打字，易于辨识和跟踪服务。

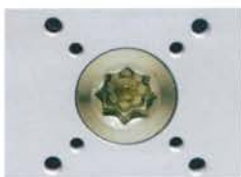

## 特殊执行器

钢外壳体执行器

不锈钢轴不锈钢活塞执行器

120°、145°、180° 转角执行机构

三位执行器

快速或慢速动作执行器

## SPECIAL ACTUATORS

Actuators with steel body

Actuators with stainless steel pinion and pistons

120° ,145° ,180° actuators

Three-positions actuator

Speedy or slow act actuators



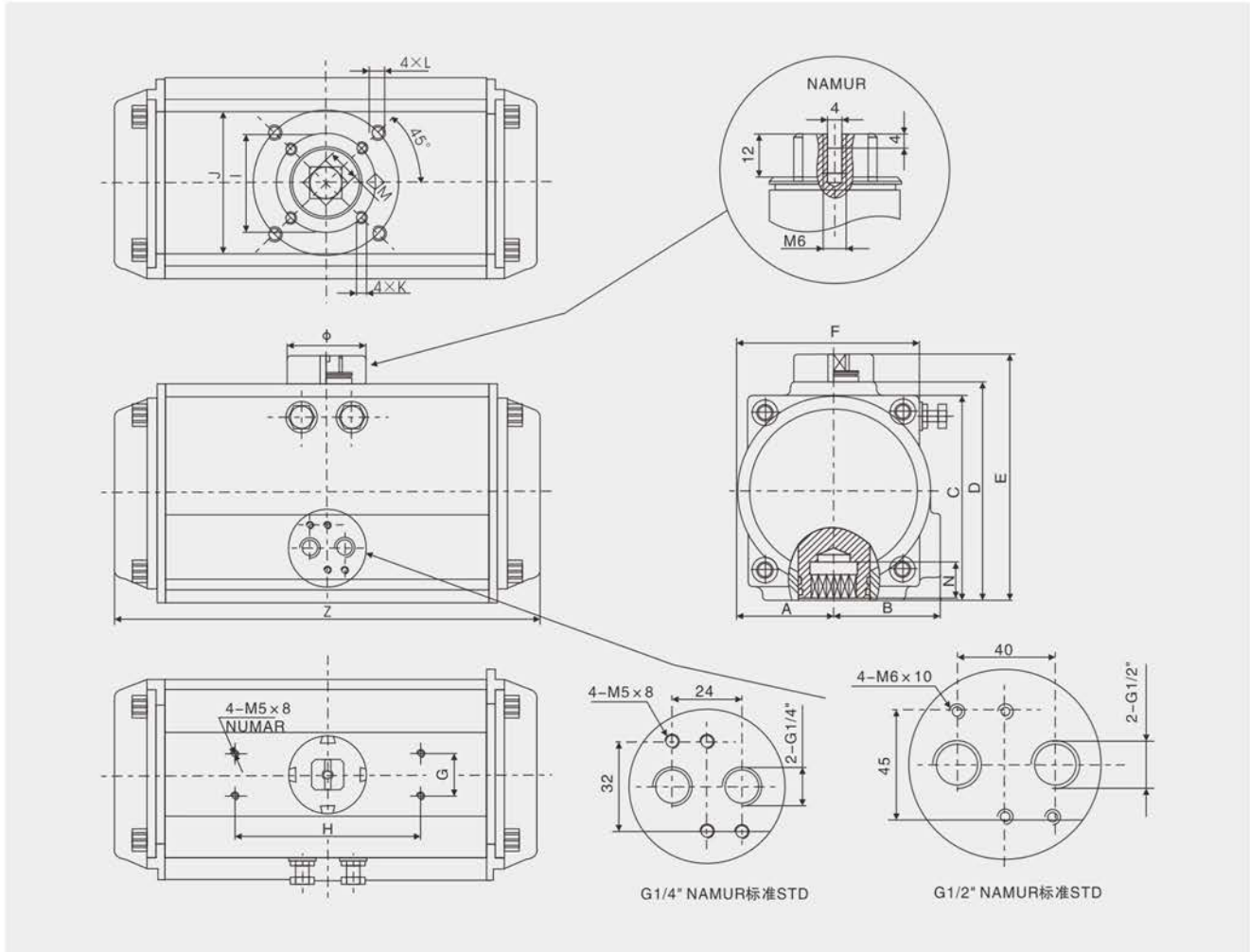

■ Dimension Table 尺寸表

型号 Mode	A	B	C	D	E	F	G	H	I	J	K	L	M	N	Z	φ	气源接口 Air connection
AT52	30	41.5	65.5	72	92	65	30	80	φ36	φ50	4-M5×8	4-M6×10	11	14	147	φ40	NAMUR G1/4"
AT65	37.5	46	81	89	109	73.5	30	80	φ50	φ70	4-M6×10	4-M8×13	14	18	170	φ40	NAMUR G1/4"
AT75	42	53	94	100	120	81	30	80	φ50	φ70	4-M6×10	4-M8×13	14	18	184	φ40	NAMUR G1/4"
AT85	46	57	98.5	108.5	128.5	92	30	80	φ50	φ70	4-M6×10	4-M8×13	17	21	206	φ40	NAMUR G1/4"
AT92	50	58.5	111	116.5	136.5	98	30	80	φ50	φ70	4-M6×10	4-M8×13	17	21	262	φ40	NAMUR G1/4"
AT105	57.5	64	122.5	134	154	109.5	30	80	φ70	φ102	4-M8×13	4-M10×16	22	26	282	φ40	NAMUR G1/4"
AT125	71	74.5	150	160	180	133.5	30	80	φ70	φ102	4-M8×13	4-M10×16	22	26	304	φ55	NAMUR G1/4"
AT140	75	77	162	174	194	137.5	30	80	φ102	φ125	4-M10×16	4-M12×20	27	31	396	φ55	NAMUR G1/4"
AT160	87	87	185	198.5	218.5	158.5	30	80	φ102	φ125	4-M10×16	4-M12×20	27	31	445	φ55	NAMUR G1/4"
AT190	103	103	216	232	262	189	30	130		φ140		4-M16×25	36	50	532	φ80	NAMUR G1/4"
AT210	113	113	235.5	257	287	210	30	130		φ140		4-M16×25	36	50	536	φ80	NAMUR G1/4"
AT240	130	130	264.5	292	322	245	30	130		φ165		4-M20×25	46	60	602	φ80	NAMUR G1/4"
AT270	147	147	299	332	362	273	30	130		φ165		4-M20×25	46	60	722	φ80	NAMUR G1/2"

■ Air Consumption 耗气量

开向体积和关向体积 Air volume opening & closing

单位Unit:L

Model 型号	Air volume opening 开向体积 (升)	Air volume closing 关向体积 (升)	Model 型号	Air volume opening 开向体积 (升)	Air volume closing 关向体积 (升)
AT52	0.12	0.16	AT140	2.5	2.2
AT65	0.21	0.23	AT160	3.7	3.2
AT75	0.3	0.34	AT190	5.9	5.4
AT85	0.43	0.47	AT210	7.5	7.5
AT92	0.64	0.73	AT240	11	9
AT105	0.95	0.88	AT270	17	14
AT125	1.6	1.4			

Air consumption rest with Air Supply. Air volume and Action cycle times, expressions:

$$L/\text{Min} = \text{Air volume}(\text{Air volume Opening} + \text{Air volume closing}) \times \left[ \frac{\text{Air Supply (Kpa)} + 101.3}{101.3} \right] \times \text{Action cycle times}(/\text{min})$$

耗气量取决于供气压力、开关行程、体积及动作次数，计算如下：

$$\text{升/分} = \text{气缸体积}(\text{开向体积} + \text{关向体积}) \times \left[ \frac{\text{供气压力(Kpa)} + 101.3}{101.3} \right] \times \text{次数/分钟}$$

Series 系列	Model 型号	Spring Q.ty 弹簧数量	Options 选项
AT □ DA	52	K5	120°, 140°, 180° for special degree operation
	65	K6	
	75	K7	
AT □ SR □	85	K8	SS Stainless Steel Pinion
	92	K9	
AT □ □ Ni	105	K10	SS Stainless Steel Pinion
	125	K11	
		K12	

Series 系列	Model 型号	Spring Q.ty 弹簧数量	Options 选项
AT □ DA	140	K5	120°, 140°, 180° for special degree operation
	160	K6	
	190	K7	
AT □ SR □	210	K8	SS Stainless Steel Pinion
	240	K9	
AT □ □ Ni	270	K10	SS Stainless Steel Pinion
		K11	
		K12	

■ Weight Table 重量表

Model 型号	AT52(Φ52)	AT65(Φ65)	AT75(Φ75)	AT85(Φ85)	AT92(Φ92)	AT105(Φ105)	AT125(Φ125)
重量(DA)	1.38kg	2.03kg	2.7kg	3.13kg	4.6kg	6.77kg	8.9kg
重量(SR)	1.45kg	2.05kg	2.9kg	3.6kg	5.22kg	6.85kg	10.11kg

Model 型号	AT140(Φ140)	AT160(Φ160)	AT190(Φ190)	AT210(Φ210)	AT240(Φ240)	AT270(Φ270)
重量(DA)	13.25kg	20.14kg	31.3kg	46.80kg	67.28kg	96.9kg
重量(SR)	15.55kg	24kg	35.25kg	54.8kg	80.2kg	118kg

注：1、SR为12根弹簧；2、重量为净重量。Note: 1. SR is 12 springs; 2. Weight is net weight.